

# Continuous Level Sensor LTM-2

## Range of application

- Continuous level measurement in metallic vessels up to 3 m in height
- Ideal for adhesive and pasty media
- Level measurement of foaming media
- Minimum product conductivity 1  $\mu\text{S}/\text{cm}$
- Substitute for float sensors
- For media with homogenous conductivity

## Application examples

- Level control in first running vessels of dosing plants
- Suitable for measuring the level in small vessels with overpressure
- Flotation cell level control
- Sump level control

## Design/Process connection

- Process connection G1.5" (see product information CLEANadapt)
- Sensor made of stainless steel (protection class IP 69 K)
- Process temperature up to 140 °C

## Features

- Compact and robust sensor with minimal size ratio
- 2-wire sensor with 4...20 mA output signal
- No adjustment after media change due to potentiometric measurement principle
- Individual parameter adjustment or programming via PC interface
- Plug and Play sensor with M12-plug as electrical connection
- Current signal for measurement range, dry signal and error signal adjustable

## Options/Accessories

- Pre-assembled connecting cable for M12-plug
- Programming adapter MPI-200 with PC software

## Function principle

The potentiometric measuring principle measures the change in the voltage ratio between the electrode rod of the sensor and the metallic wall of the filled tank. An electric flow field arises in the medium due to the conductivity of the medium and its capacitive properties. This gives rise to a voltage ratio that is proportional to the immersed part of the rod.

Because only the ratio of the voltages is considered, the properties of the medium, in particular the electrical conductivity, do not enter into the measurement result. The sensor also provides information on the immersion situation of the electrode rod in the medium by means of a second, patent-pending measurement system. This system analyzes electrical resonance properties to detect foam and suppress it in the results, and to reliably prevent erroneous measurements due to adhesions.

## Authorizations



## Level sensor LTM-2



## Function principle

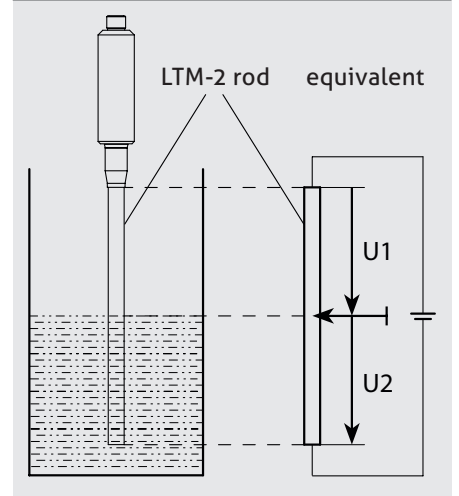

Specification		
Rod length EL		3000 mm max.
Rod diameter		10 mm
Measurement range		50...3000 mm
Process connection	thread	G1.5"
Process pressure		max. 16 bar
Tightening torque		10 Nm
Materials	head adapter isolating part rod	stainless steel 1.4305 stainless steel 1.4301 PEEK stainless steel 1.4404, $R_a \leq 0.8 \mu\text{m}$
Temperature range	ambient storage process	0...70 °C -40...85 °C -10...140 °C
Level measurement	parameters/settings	see table
Resolution	rod length > 500 mm rod length < 500 mm	< 0.1 % of upper range value (= rod length) < 0,5 mm
Linearity		< 1.0 % of upper range value (= rod length)
Reproducibility	rod length > 500 mm rod length < 500 mm	< 0.2 % of upper range value (= rod length) < 1,0 mm
Response time		< 100 ms
Supply		19...36 V DC
Output	signal burden parameters/settings	analog 4...20 mA, galvanic separated to housing, 2-wire loop see separate graphic see table
Electrical connection		M12-plug, 1.4301, 4-pin
Protection class		IP 69 K
Weight		550 g with rod length 1.5 m

Possible parameter/Settings	
<b>4...20 mA current signal</b>	
Underrange	3.80; 3.95; 4.00 mA
Overrange	20.00; 20.05; 20.50 mA
Warning and failure signal (e.g. dry run)	3.80; 3.95; 4.00 mA 20.00; 20.05; 20.50; 21.00; 21.20 mA
<b>Level measurement</b>	
Zero/Gain	-50...50 % / 50...150 %
Damping	0; 0.1; 0.2; 0.5; 1; 2; 5 s

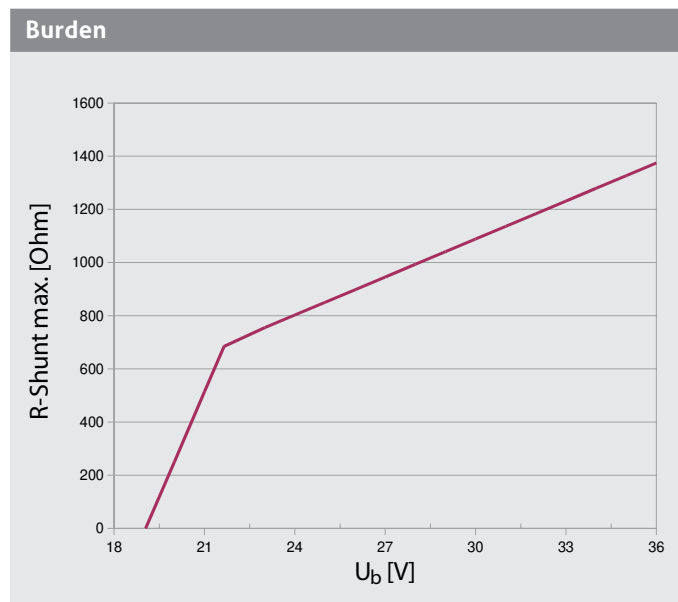

## Conventional usage



- Not suitable for applications in explosive areas.
- Not suitable for applications in security-relevant equipment (SIL).

## Dimensional drawing LTM-2

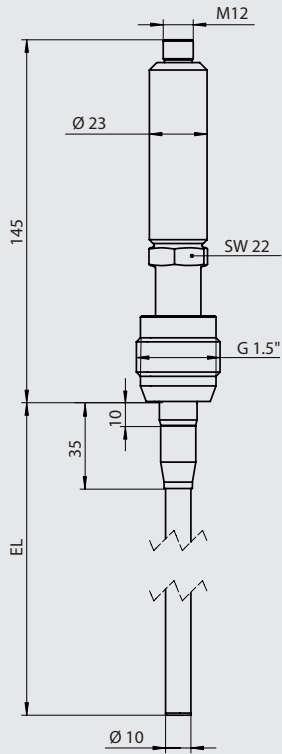

**Mechanical connection/Installation**



- **Attention!** Do not shorten the sensor rod!
- To guarantee a safety function of the sensor, the G1.5" thread must have a good electrical contact to the vessel wall! Because of this, **do not use any sealing materials like Teflon or others!**
- The sensor rod must not have any electrical contact to the vessel wall! Please also attend that the rod may swing if there are turbulences in the vessel!
- In Flotation Cells, non-metallic and/or rubber lined vessels, the LTM-BRK bracket needs to be used in conjunction with the LTM level probe

**Configuration M12-plug**

- 1: +supply
- 2: -supply 4...20 mA
- 3: data link to PC interface, must not be connected
- 4: data link to PC interface, must not be connected

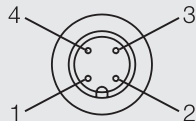

**Connecting 2-wire system**

- 1: PLC
- 2: M12-plug
- 3: 4...20 mA current loop

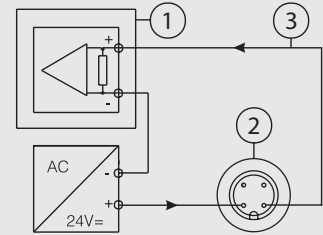

**Cable with M12-plug and LED**



The LTM-2 sensor is a 2-wire sensor with 4...20 mA output signal. Use of a cable with internal LEDs will cause a measurement error!

**Power supply cable**



To guarantee a trouble-free function the power supply cable should be shielded and grounded at the electrical control box

**M12-plug with LED**

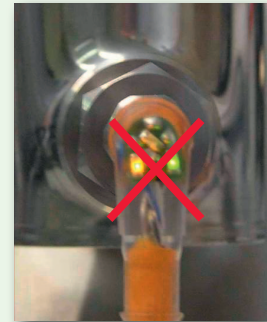

Programming adapter MPI-200



Connection of programming adapter MPI-200

- 1: External power supply via M12-plug (optional)
- 2: USB port for connection to PC incl. power supply if not supplied external
- 3: Connection cable to LTM-2 sensor

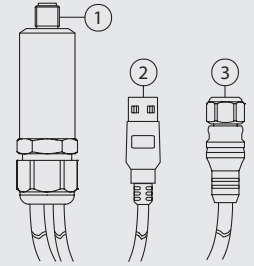

Signal flow while parametrization

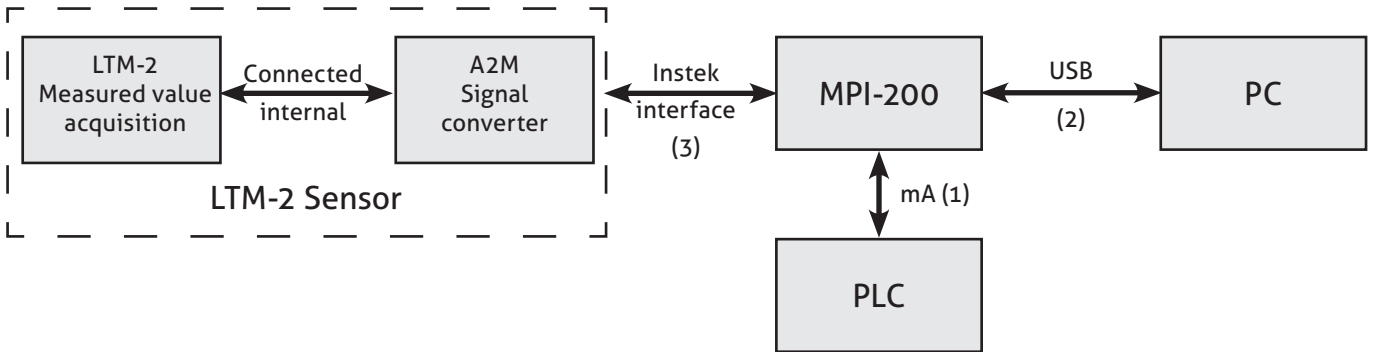

Adjustment of LTM-2 parameters

Using the PC based software and the programming adapter MPI-200 the following NSL-M parameters can be adjusted or changed in situ (with vessel) or alternatively on the bench (in simulation mode): e.g.

4...20 mA Signal

- Level for (4 / 20) mA output signal
- Warning signal "dry run"
- Error signal "failure"
- Signallimit for under- and overrange
- Error signal "over- and underflow"
- Signal simulation (3.80...21.20 mA)

Level Measuring

- Level zero / offset
- level slope / gain
- Damping / filter
- Physical Unit

Mounting Position

Configuration software

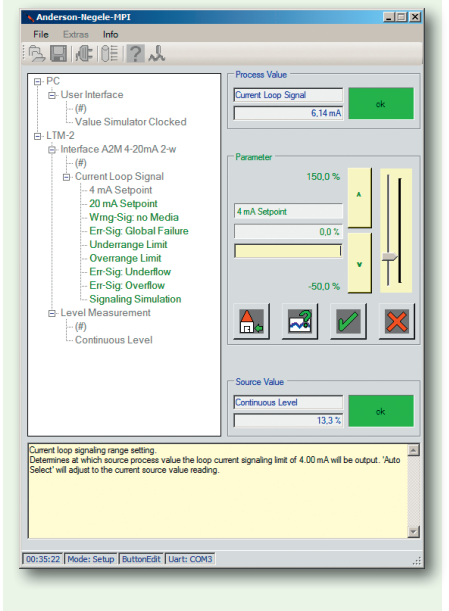

Parameter/Signal sequence

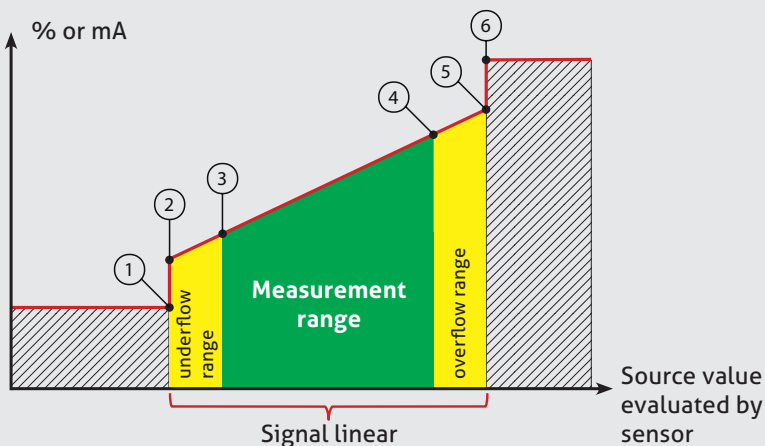

- 1: Error signal: underflow
- 2: Underflow limit
- 3: 4 mA setpoint
- 4: 20 mA-setpoint
- 5: Overflow limit
- 6: Error signal: overflow

Warning signal: dry run

- Sensor is not immersed into a media
- Signal can be adjusted from 3,8 up to 21,2 mA



**Note**

- A list of the parameter settings in the level switch is supplied with the device. These parameter settings and those changed by the user can be printed out in the software using the MPI-200 programming adapter.
- When making settings, note the help texts in the MPI software. They provide useful information on changing the selected parameter.

The default setting of the LTM-2 level switch is for operation with aqueous media without requiring special adjustments. In exceptional cases involving highly critical media or special tank contours (with internal structures such as a pipe), it may be necessary to make adjustments to some of the parameters (the parameter can be found under the path specified below):

**Coarse adjustment of adhesion detection**

For installation from above or adhesions between the rod end and wall for installation from below

**Setup Menu**

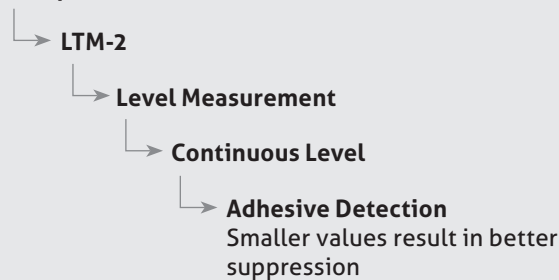

**Fine adjustment of adhesion detection**

For installation from above or adhesions between the rod end and wall for installation from below

**Setup Menu**

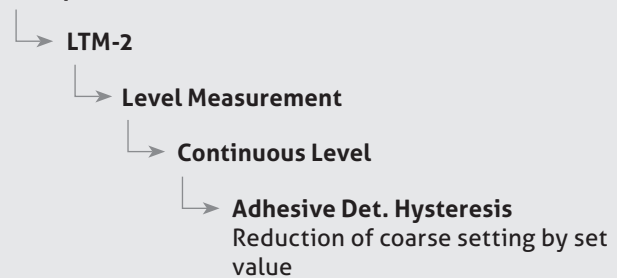

**Coarse adjustment of the sensitivity**

In case of foam or adhesions to the lower end of the switch (4 mA signal)

**Setup Menu**

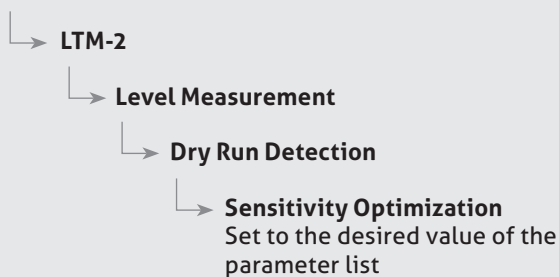

**Fine adjustment of the sensitivity**

Fine adjustment for detecting the medium

**Setup Menu**

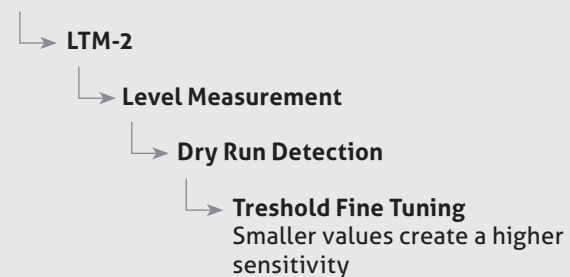

**Prevention of signal jumps in turbulent media**

To damp signal jumps at the lower end of the sensor (4 mA signal)

**Setup Menu**

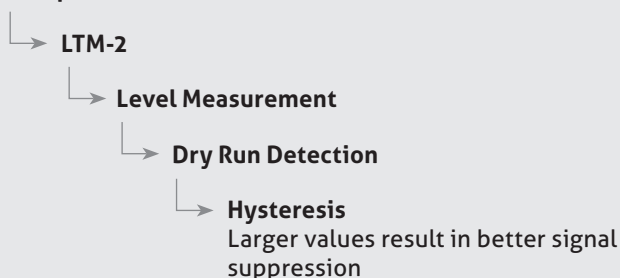

## System parameter suggestion



- To generate the system parameter suggestion, there should be no media in the vessel.

## Transport/Storage



- No outdoor storage
- Dry and dust free
- Not exposed to corrosive media
- Protected against solar radiation
- Avoiding mechanical shock and vibration
- Storage temperature -40...+85 °C
- Relative humidity maximum 98 %

## Reshipment



- Sensors and process connection shall be clean and must not be contaminated with dangerous media and/or heat-conductive paste! Note the advice for cleaning!
- Use suitable transport packaging only to avoid damage of the equipment!

## Cleaning/Maintenance



- In case of using pressure washers, don't point nozzle directly to electrical connections!

## Standards and Guidelines



- You have to comply with applicable regulations and directives

## Notice on conformity



- Applicable guidelines:
- Electromagnetic compatibility 2004/108/EC
  - The accordance with applicable EU-guidelines is confirmed with CE-labeling of the device.
  - You have to guarantee the compliance of all guidelines applicable for the entire equipment.

## Disposal



- This instrument is not subject to the WEEE directive 2002/96/EC and the respective national laws.
- Pass the instrument directly on to a specialised recycling company and do not use the municipal collecting points.

Application sample



Order Code

**LTM-2** (potentiometric level sensor for mining application, 2-wire technology, connecting head = 23 mm, wetted material 1.4404, electrical connection M12-plug, dry run adjustment to 4 mA)

Version

**00** (standard)

**Rod length EL**, choose length in a 10 mm raster, e.g.: 220, 230, 240 etc., max length 3000 mm.

**50...3000** (material 1.4404)

Process connection

**G15** (standard thread G1.5")

Installation position

**O** (installation from top)

Output signal

**A2M** (4...20 mA, analog, 2-wire)

Parameter configuration

**X** (standard, measurement length = rod length)

**RM XXX** (active measurement length measured from rod end)

LTM-2 / 00 / 1500 / G15 / O / A2M / RM 1000

Accessories

Programming adapter  
MPI-200

Incl. PC software

Programming adapter MPI-200

